



Labculture.

Labculture®  
Labculture® • **RELIANT**

NSF UL 61010 JIS K3800 SFDA YY-0569 EN 12469 SANS 12469

Labculture Class II, Type A2  
Biosafety Cabinet, Model LA2-4A\_-E.

## Class II, Type A2 and B2 Biological Safety Cabinets

The Most Certified Energy-Efficient, Safe, and Ergonomic  
Biosafety Cabinet in the World

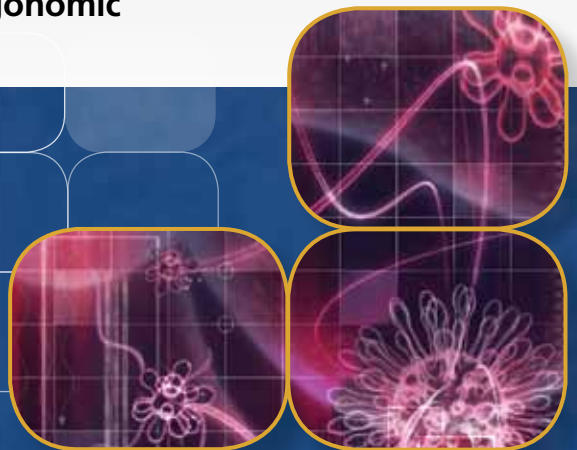

**ESCO**

WORLD CLASS. WORLDWIDE.

# LABCULTURE CLASS II TYPE A2 (LA2) and B2 (LB2) BIOSAFETY CABINETS,

RS 232 SERIAL  
INTERFACE PORT



Zero voltage  
relay contact



## RS 232 Port and Zero Volt Relay Contact

- RS 232 Port to send operational information to Building Management System (BMS)
- Zero Volt Relay Contact to turn ON/OFF exhaust blower and signal the building alarm



## Airflow Sensor

- Monitors real-time airflow for safety
- Alert the user if airflow is insufficient

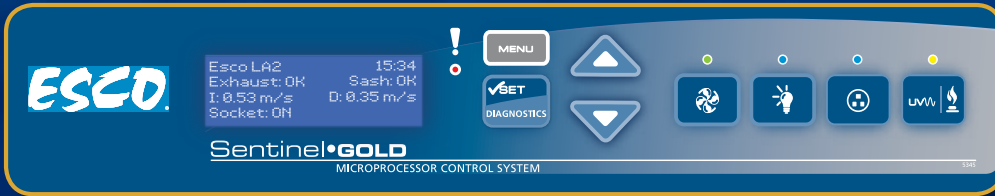

## Sentinel™ Gold Microprocessor Controller

- Displays all safety information on one screen
- Centered and angled down for easy reach & viewing
- Selectable Quickstart mode for fast operation



## Single Piece Wall

- Large radius for easy cleaning
- Side-mounted electrical outlets and staggered service fixtures, for easy reach



## Single Piece Work Tray

- Recessed to contain spillage
- Curved grill to prevent blockage



## Raised Arm Rest

- Helps prevent grille blocking
- Comfortable working posture

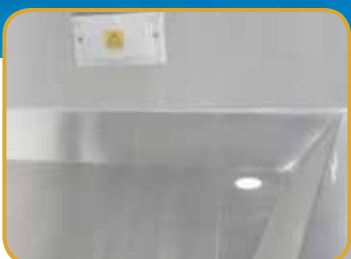

## Angled Drain Pan

- Easy to clean
- Does not harbor contaminants



Available in 0.9, 1.2, 1.5, 1.8 and 2.4 meter models (3', 4', 5', 6' and 8'). Shown with optional telescoping stand.



NSF 49, UL 61010, IIS K3800, SFDA YY-0569, EN 12469, SANS 12469  
Esco Labculture Class II Type A2 (LA2) has passed more performance tests in more languages, for more certifications throughout more countries than any other biological safety cabinet in the world.

Labculture® | Labculture® •RELIANT

LA2 & LR2 Class II Type A2 / LB2 Class II Type B2 • Biological Safety Cabinets

# FEATURING ADVANCED MICROPROCESSOR CONTROLLER



## Pressure Switch (LB2 only)

- Temperature independent
- Fast response

## Energy Efficient DC ECM Motor

- Powered by latest generation DC ECM motor, that is more efficient than legacy ECM and VFD motors
- 70% Energy savings compared to AC motor
- Stable airflow, despite building voltage fluctuations & filter loading
- Night Setback mode to further reduce power consumption by 60%

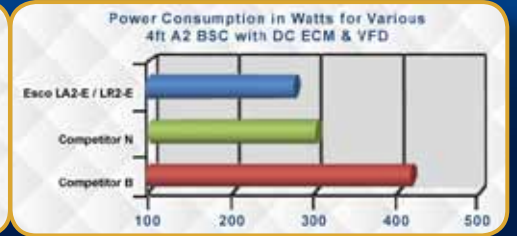
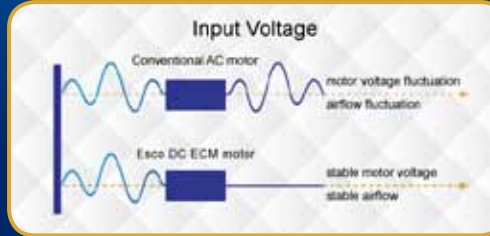

## ULPA Filter

- 10x Filtration efficiency of HEPA filter
- Creates ISO Class 3 work zone instead of industry-standard ISO Class 5

Esco cabinets use ULPA filters (per IEST-RP-CC001.3) / H14 per EN 1822 instead of H13 HEPA filters used on many BSCs in the market.

HEPA filters only offer 99.99% typical efficiency at 0.3 micron, while ULPA filters provide 99.999% typical efficiency for particle sizes of 0.1 to 0.3 micron.

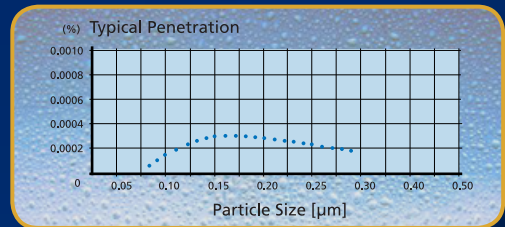

## Dynamic Chamber

- Blower plenum and side walls are surrounded by negative pressure
- Prevent contaminants from escaping outside

- Positive pressure
- Negative pressure



## ISOCIDE™ powder coat

- Silver-ion impregnated powder coat
- Inhibit microbial growth to improve safety

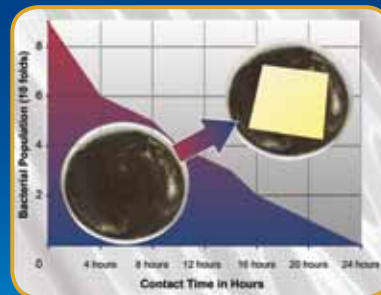

## The Most Certified BSC in the World

	Biosafety Cabinets	Air Quality	Filtration	Electrical Safety
Standards Compliance	NSF / ANSI 49, USA* EN 12469, Europe** JIS K 3800, Japan** SFDA YY-0569, China	ISO 14644.1, Class 3, Worldwide JIS B9920, Class 3, Japan JIS BS5295, Class 3, Japan US Fed Std 209E, Class 1 USA	EN-1822 (H14), Europe IEST-RP-CC001.3, USA IEST-RP-CC007, USA IEST-RP-CC034.1, USA	UL-C-61010A-1, USA CSA22.2, No.1010-192, Canada EN-61010-1, Europe IEC61010-1, Worldwide

\* The NSF / ANSI 49 certified models are: LA2-4A1-E, LA2-4A2-E, LA2-4A3-E, LA2-5A1-E, LA2-5A2-E, LA2-5A3-E, LA2-6A1-E, LA2-6A2-E, LA2-6A3-E,

LB2-4B1-E, LB2-4B2-E, LB2-4B3-E, LB2-5B1-E, LB2-5B2-E, LB2-5B3-E, LB2-6B1-E, LB2-6B2-E and LB2-6B3-E.

Note: LA2 cabinets are certified to NSF, EN, JIS, and SFDA. LB2 cabinets are certified to NSF and SFDA.

\*\* EN 12469 and JIS K 3800 are applicable in LA2 model only.



# LABCULTURE RELIANT CLASS II TYPE A2 BIOSAFETY CABINETS,

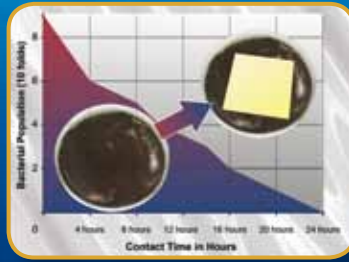
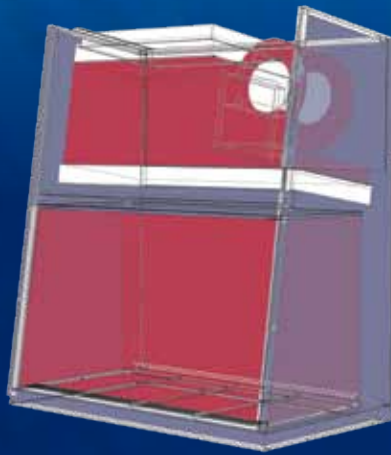

## ISOCIDE™ powder coat

- Silver-ion impregnated powder coat
- Inhibit microbial growth to improve safety

## Dynamic Chamber

- Blower plenum and side walls are surrounded by negative pressure
- Prevent contaminants from escaping outside

- Positive pressure
- Negative pressure



## Single Piece Wall

- Large radius for easy cleaning
- Side-mounted electrical outlets and staggered service fixtures, for easy reach

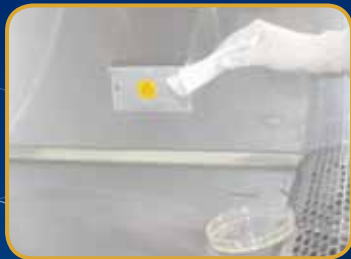

## Single Piece Work Tray

- Recessed to contain spillage
- Curved grill to prevent blockage



## Raised Arm Rest

- Helps prevent grille blocking
- Comfortable working posture



## Angled Drain Pan

- Easy to clean
- Does not harbor contaminants

Available in 0.9, 1.2, 1.5, 1.8 and 2.4 meter models (3', 4', 5', 6' and 8'). Shown with optional telescoping stand.



NSF 49, UL 61010,



# FEATURING SIMPLE SWITCHES AND GAUGE



## Energy Efficient DC ECM Motor

- Powered by latest generation DC ECM motor, that is more efficient than legacy ECM and VFD motors
- 70% Energy savings compared to AC motor
- Stable airflow, despite building voltage fluctuations & filter loading
- Night Setback mode to further reduce power consumption by 60%

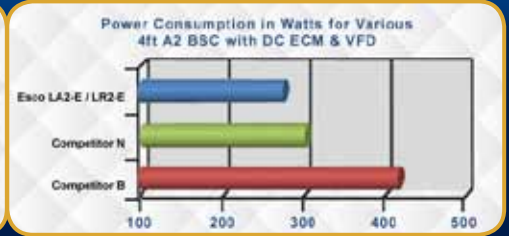
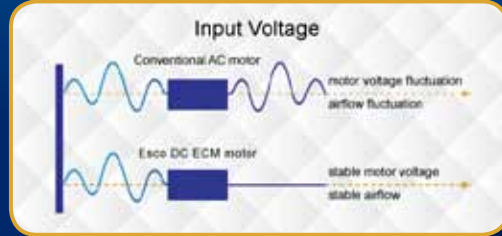

## ULPA Filter

- 10x Filtration efficiency of HEPA filter
- Creates ISO Class 3 work zone instead of industry-standard ISO Class 5

Esco cabinets use ULPA filters (per IEST-RP-CC001.3) / H14 per EN 1822 instead of H13 HEPA filters used on many BSCs in the market.

HEPA filters only offer 99.99% typical efficiency at 0.3 micron, while ULPA filters provide 99.999% typical efficiency for particle sizes of 0.1 to 0.3 micron.

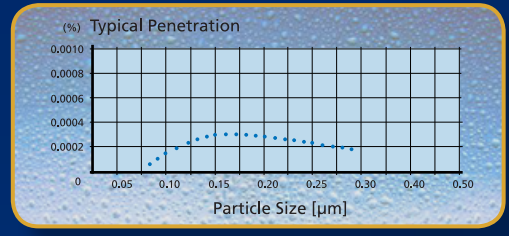

## Rocker Switches and Pressure Gauge

- Easy to use switches
- Displays filter loading status
- Manually adjustable UV timer



## Adjustable UV Timer

- Easily adjustable to desired minutes or hours
- Prolongs UV lamp, for not turning it ON overnight



## Certification

	Biosafety Cabinets	Air Quality	Filtration	Electrical Safety
Standards Compliance	NSF / ANSI 49 NSF	ISO 14644.1, Class 3, Worldwide JIS B9920, Class 3, Japan JIS BS5295, Class 3, Japan US Fed Std 209E, Class 1 USA	EN-1822 (H14), Europe IEST-RP-CC001.3, USA IEST-RP-CC007, USA IEST-RP-CC034.1, USA	UL-C-61010A-1, USA CSA22.2, No.1010-192, Canada EN-61010-1, Europe IEC61010-1, Worldwide

\* The NSF / ANSI 49 certified models are: LR2-4S1-E, LR2-4S2-E, LR2-4S3-E, LR2-5S1-E, LR2-5S2-E, LR2-5S3-E, LR2-6S1-E, LR2-6S2-E, and LR2-6S3-E.

# LA2 and LR2 CLASS II TYPE A2 BIOSAFETY CABINETS



## Cabinet Filtration System

- Ambient air is pulled through front grille to create inflow, without going into the work surface. Inflow is joined by half of the downflow, to create front air curtain that is fine-tuned to create a large performance envelope. The combined air stream travels through the back air column towards the blower.
- Approximately 1/3 of the air in the common plenum is exhausted through the ULPA filter to the room. The remaining 2/3 of the air is passed through the downflow ULPA filter and into the work area as a vertical laminar flow air to create ISO Class 3 work surface and prevents cross contamination.
- Near the work surface, the downflow splits. About Half goes to the front grille, and half goes to the rear grille. A small portion enters the side capture zones to prevent dead air corners (small blue arrows).
- The design was optimized to give large performance envelope, that provides operator and product protection at wide Inflow and Downflow variation from the Nominal point.

## The Performance Envelope Concept

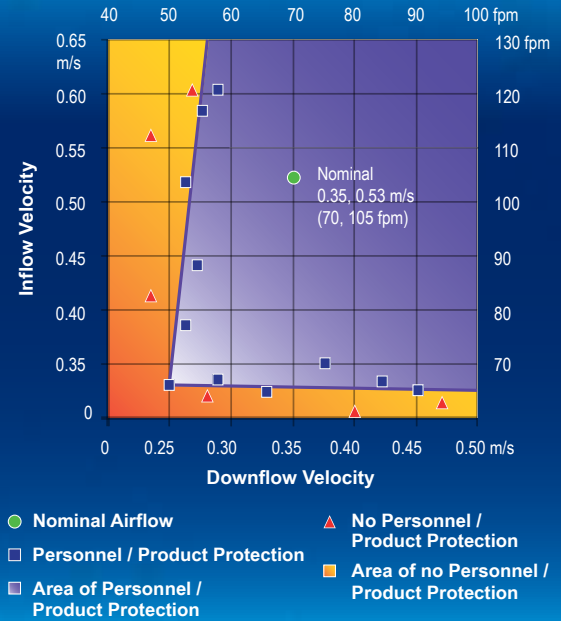

- Dynamic air barrier, where inflow and downflow converge
- Side capture zones
- ULPA-filtered air
- Unfiltered / potentially contaminated air
- Room air / Inflow air

## Model LA2 and LR2 Biological Safety Cabinet Technical Specifications

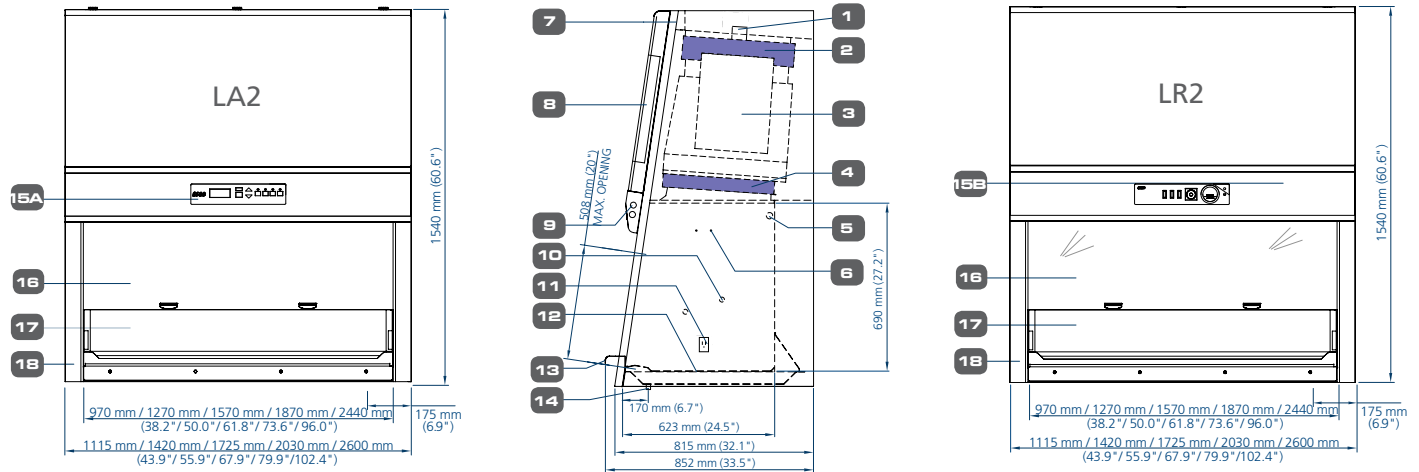

- |  |  |   |   |
|--|--|---|---|
| 1. Airflow Sensor (LA2 only)                 | exhaust and alarm system   | outlet in workzone) (1.2, 1.5, 1.8 and 2.4 meter / 4', 5', 6' & 8' models - two single outlets in workzone) | 15B (LR2) Simple Switches Controller, Pressure Gauge, and Manual UV Timer |
| 2. Exhaust ULPA Filter                       | 8. Electrical / Electronics Panel  | 12. Stainless Steel Single-piece Work Tray  | 16. Safety Glass Sliding Sash Window                                      |
| 3. Energy-efficient DC ECM Blower            | 9. Fluorescent Lamps   | 13. Stainless Steel Arm Rest  | 17. Single-piece Stainless Steel Back Wall and Side Walls                 |
| 4. Downflow ULPA Filter, angled              | 10. Plugged Service Fixture provisions (2 on each side)                          | 14. Drain Valve Retrofit Kit Provision  | 18. Removable Side Panel for plumbing access                              |
| 5. UV light Retrofit Kit Provision           | 11. Electrical Outlet Retrofit Kit Provision (0.9 meter / 3' model - one single) | 15A. (LA2 and LB2 only) Sentinel™ Microprocessor Control System   |   |
| 6. IV bar Retrofit Kit Provision             |  |   |   |
| 7. RS 232 Port, zero volt relay contacts for |  |   |   |

## Optional Exhaust Collar Positions for Thimble-Ducting for LA2 and LR2 Models

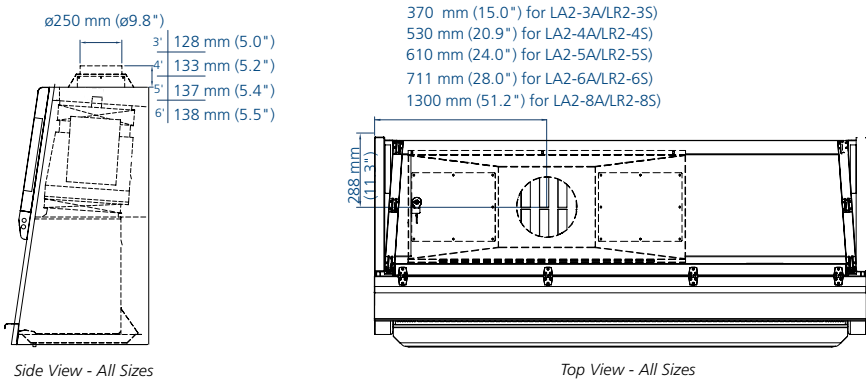



# LB2 CLASS II TYPE B2 BIOSAFETY CABINET

For Biohazard and Chemical Hazard

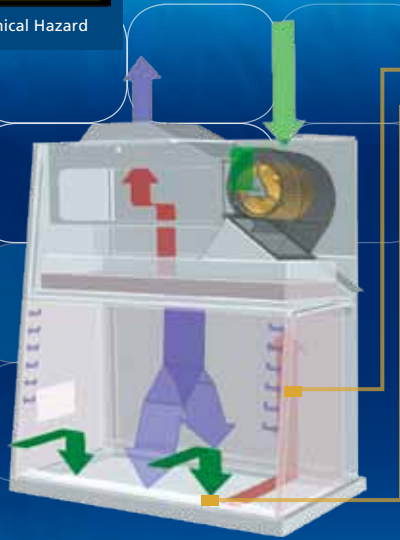

- ULPA-filtered air
- Unfiltered / potentially contaminated air
- Room air / Inflow air

## Cabinet Filtration System

Side capture zones  
Dynamic air barrier, inflow and forward-directed downflow air converge

- Ambient air is pulled through the front grille to prevent contamination of the work surface and work product. The inflow does not mix with the clean air within the cabinet work zone.
- Ambient air is taken in through a pre-filter at the top of the cabinet, and passes through the downflow ULPA filter, entering the work zone as laminar flow. The uniform, non-turbulent air stream protects against cross contamination within and throughout the work area.
- Near the work surface, the downflow air stream splits with a portion moving toward the front air grille, and the remainder moving to the rear air grille. A small portion of the ULPA filtered downflow enters the intake perforations at the side capture zones at a higher velocity (small blue arrows).

- A combination of inflow and downflow air streams forms an air barrier that prevents contaminated room air from entering the work zone, and prevents work surface emissions from escaping the work zone. The downflow combined with the inflow air enters the common plenum.
- All air in the common plenum is HEPA-filtered and exhausted via a dedicated ducting system to the external environment.

## Model LB2 Biological Safety Cabinet Technical Specifications

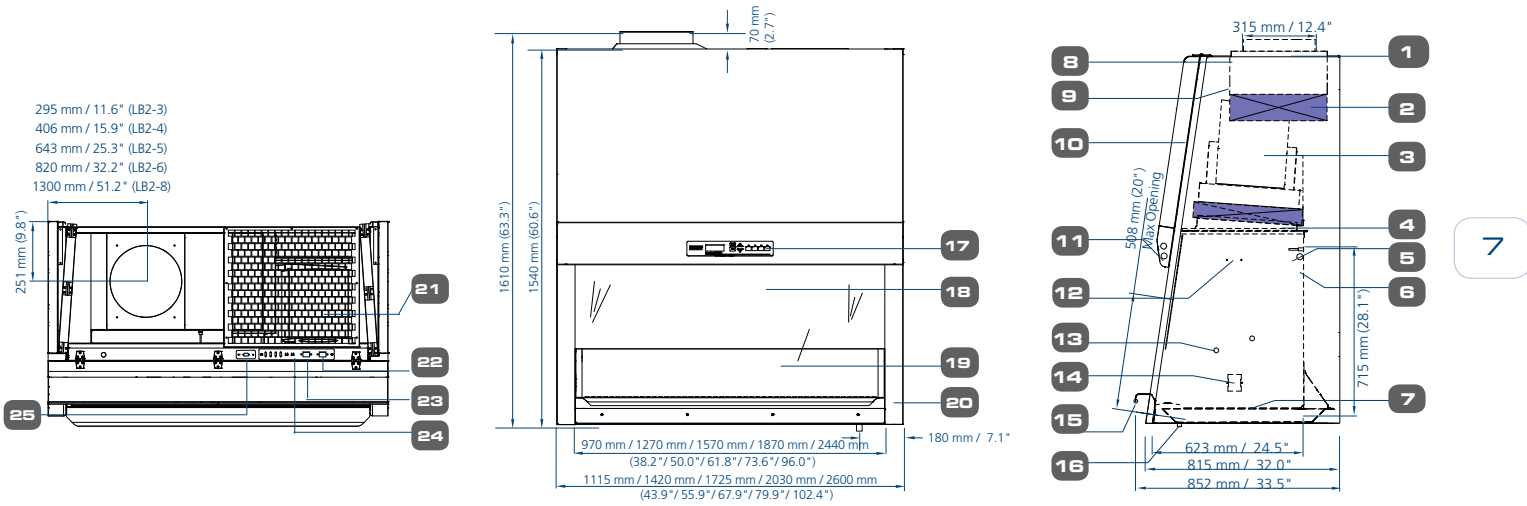

- |   |   |
|---|---|
| 1. Exhaust Collar   | 15. Stainless Steel Arm Rest                              |
| 2. Exhaust HEPA Filter  | 16. Drain Valve Retrofit Kit Provision                    |
| 3. Energy-efficient DC ECM Blower   | 17. Esco Sentinel™ Gold Microprocessor Control System     |
| 4. Downflow ULPA Filter, angled   | 18. Safety Glass Sliding Sash Window                      |
| 5. Downflow Sensor  | 19. Single-piece Stainless Steel Back Wall and Side Walls |
| 6. Standard UV light Retrofit Kit™ Provision  | 20. Removable Side Dress Panel for plumbing access        |
| 7. Single-piece Stainless Steel Work Tray   | 21. Pre filter  |
| 8. Pressure Switch Port   | 22. Cabinet Power Inlet                                   |
| 9. Exhaust Sensor   | 23. Zero Volt Relay Contact for exhaust system            |
| 10. Electrical / Electronic Panel   | 24. Zero Volt Relay Contact for remove alarm              |
| 11. Fluorescent Lamp  | 25. RS 232 Port   |
| 12. Standard IV bar Retrofit Kit™ Provision (Maximum load for IV bar is 6 kg / 13 lbs)  |   |
| 13. Service Fixture Retrofit Kit Provisions (2 on each side)  |   |
| 14. Electrical outlet Retrofit Kit Provision (0.9 meter / 3' model - one single outlet in workzone) (1.2, 1.5, 1.8 and 2.4 meter / 4', 5', 6' & 8' models - two single outlets in workzone) |   |

## Recommended B2 Cabinet Installation

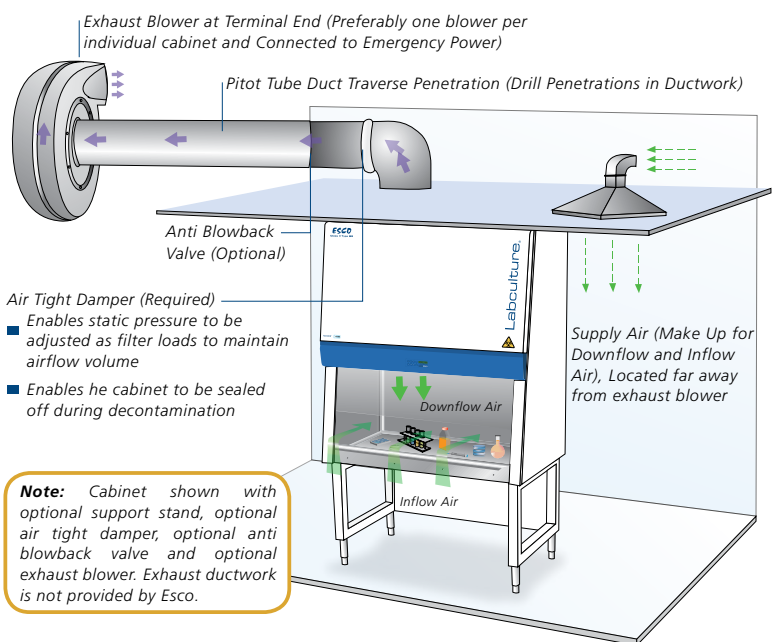

## LA2 and LB2 Sentinel Gold Microprocessor Control System

LCD simultaneously displays time, airflow & sash status, inflow and downflow velocities, and status remarks on one screen, without scrolling.



Diagnostics button, to easily check the cabinet operating parameters and assist servicing. Also serves as audible alarm mute button.

Large touchpad control buttons provides good tactile feedback.

Color coded LED: green for fan; blue for FL lights and outlets; and orange for UV lamp.

Programmable UV light timer extends UV lamp life.



### Accessories for Labculture® and Labculture® Reliant Biological Safety Cabinets

Model	Description
SPL-_A0 gen2	Leveling Feet Stand, Sitting Posture, Adjustable 28" to 30", _ Indicates Size in Feet (3,4,5,6), Example: SPL-4 A0 gen2 for 4 ft, Shipped Flat
SPL-_B0 gen2	Leveling Feet Stand, Standing Posture, Adjustable 34", _ Indicates Size in Feet (3,4,5,6), Example: SPL-4B0 gen2 for 4 ft, Shipped Flat
SPC-_A0 gen2	Caster Wheel Stand, Sitting Posture, 710 mm (28") Fixed Height, _ Indicates Size in Feet (3,4,5,6), Ex: SPC-4 A0 gen2 for 4 ft, Shipped Flat
SPC-_B0 gen2	Caster Wheel Stand, Standing Posture, 860 mm (34") Fixed Height, _ Indicates Size in Feet (3,4,5,6), Ex: SPC-4B0 gen2 for 4 ft, Shipped flat
STL-_A0	Telescoping Feet Stand, Manually Adjustable 28" to 36" by Pins, _ Indicates Size in Feet (3,4,5,6), Example: STL-4A0 for 4 ft, Shipped Flat
SPM-_A_	Hydraulic Stand, Electrically Adjustable 28" to 36", _ Indicates Size in Feet (4,5,6), Example: SPM-4A1 for 4 ft, 230 V, Shipped assembled
SF-1_40	Service Fixture. Indicate the type on the blank "_" as follows: G: Gas, V: Vacuum, W: Water. Example: SF-1G40 for Gas.
IV-XXXX	IV bar kit, Includes 6 hooks, Max Load 6 Kg (13 lbs), Specify model when ordering, Field installed, XXXX = Internal width in mm minus 10 mm
DAMPER 10	Air Tight Damper for all Class II LA2 Cabinets, 9.8" diameter x 9.8" height (fits inside 10" duct)
ECO-LA2-_	Thimble exhaust transition, for LA2 cabinets. Specify size when ordering (e.g. ECO-LA2-4 for 4 feet)
ABBV-10	Anti Blow Back Valve, automatically shuts exhaust, preventing back flow in the duct, 10" diameter
DCN-BAG	Plastic decon bag for formalin decon on all BSC
PORT	Air tight cable port, installed on right side wall. Holds 1 to 4 cables. Specify When Ordering
FOOT REST	Ergonomic Foot Rest, free-standing, angled surface, easily adjustable from 3" to 11" in 1" increment, 20" wide, Black Rubber Matte
PVC ARM	PVC Armrest, for Operator Comfort, Easy to Clean, 28" Long
M-POUCH	Microscope Viewing Pouch. Factory Installed. Specify when Ordering



SPC-\_A0 Gen2



SPL-\_B0 Gen2



STL-\_A0



SPM-4A1



DAMPER 10



ECO-LA2-\_



ABBV-10

## Comprehensive Performance Testing At Esco



Every Labculture model manufactured by Esco is individually tested, documented by serial number and validated with the following test methods.

- Inflow and downflow velocity.
- PAO aerosol challenge for filter integrity.
- Airflow pattern visualization.
- Electrical safety to IEC61010-1.
- Additional KI-Disc containment and microbiological testing are performed on statistical sampling basis.





## Class II Type A2 Biological Safety Cabinets

TECHNICAL SPECIFICATION						
Labculture® Class II A2		LA2-3A_-E	LA2-4A_-E	LA2-5A_-E	LA2-6A_-E	LA2-8A_-E
Labculture® Reliant Class II A2		LR2-3S_-E	LR2-4S_-E	LR2-5S_-E	LR2-6S_-E	LR2-8S_-E
Nominal Size		0.9 meters ( 3')	1.2 meters ( 4')	1.5 meters ( 5')	1.8 meters ( 6')	2.4 meters ( 8')
External Dimensions * (W x D x H)		1115 x 852 x 1540 mm 44.0" x 33.5" x 60.6"	1420 x 852 x 1540 mm 56.0" x 33.5" x 60.6"	1725 x 852 x 1540 mm 68.0" x 33.5" x 60.6"	2030 x 852 x 1540 mm 80.0" x 33.5" x 60.6"	2600 x 852 x 1540 mm 102.4" x 33.5" x 60.6"
Gross Internal Dimensions (W x D x H)		970 x 623 x 670 mm 38.2" x 24.5" x 26.4"	1270 x 623 x 670 mm 50.0" x 24.5" x 26.4"	1570 x 623 x 670 mm 61.8" x 24.5" x 26.4"	1870 x 623 x 670 mm 73.6" x 24.5" x 26.4"	2440 x 623 x 670 mm 96.0" x 24.5" x 26.4"
Usable Work Area		0.45 m <sup>2</sup> (4.8 sq.ft.)	0.6 m <sup>2</sup> (6.5 sq.ft.)	0.75 m <sup>2</sup> (8.1 sq.ft.)	0.9 m <sup>2</sup> (9.7 sq.ft.)	1.2 m <sup>2</sup> (13 sq.ft.)
Tested Opening		229 mm (9")	229 mm (9")	229 mm (9")	203 mm (8")	203 mm (8")
Working Opening		274 mm (10.8")	274 mm (10.8")	274 mm (10.8")	248 mm (9.8")	248 mm (9.8")
Average Airflow Velocity	Inflow	0.53 m/s (105 fpm)				
	Downflow	0.35 m/s (70 fpm)	0.35 m/s (70 fpm)	0.35 m/s (70 fpm)	0.33 m/s (65 fpm)	0.33 m/s (65 fpm)
Airflow Volume	Inflow	424 m <sup>3</sup> /h (251 cfm)	555 m <sup>3</sup> /h (328 cfm)	686 m <sup>3</sup> /h (406 cfm)	724 m <sup>3</sup> /h (426 cfm)	945 m <sup>3</sup> /h (560 cfm)
	Downflow	628 m <sup>3</sup> /h (363 cfm)	822 m <sup>3</sup> /h (476 cfm)	1016 m <sup>3</sup> /h (588 cfm)	1210 m <sup>3</sup> /h (700 cfm)	1579 m <sup>3</sup> /h (914 cfm)
	Exhaust	424 m <sup>3</sup> /h (251 cfm)	555 m <sup>3</sup> /h (328 cfm)	686 m <sup>3</sup> /h (406 cfm)	724 m <sup>3</sup> /h (426 cfm)	945 m <sup>3</sup> /h (560 cfm)
	Required Exhaust With Optional Thimble Exhaust Collar	529 m <sup>3</sup> /h (311 cfm)	764 m <sup>3</sup> /h (450 cfm)	1116 m <sup>3</sup> /h (657 cfm)	1164 m <sup>3</sup> /h (685 cfm)	1540 m <sup>3</sup> /h (913 cfm)
	Static Pressure For Optional Thimble Exhaust Collar	32 Pa / 0.12 in H <sub>2</sub> O	49 Pa / 0.19 in H <sub>2</sub> O	62 Pa / 0.24 in H <sub>2</sub> O	79 Pa / 0.31 in H <sub>2</sub> O	100 Pa / 0.40 in H <sub>2</sub> O
ULPA Filter Typical Efficiency		>99.999% for particle size between 0.1 to 0.3 microns per IEST-RP-CC001.3 / H14 per EN 1822				
Sound Emission**	NSF / ANSI 49	62.5 dBA	63 dBA	63.5 dBA	64 dBA	64.5 dBA
	EN 12469	59.5 dBA	60 dBA	60.5 dBA	61 dBA	61.5 dBA
Fluorescent Lamp Intensity		> 1230 Lux (> 114 foot-candles)	> 1400 Lux (> 130 foot-candles)	> 1070 Lux (> 100 foot-candles)	> 1230 Lux (> 114 foot-candles)	> 1230 Lux (> 114 foot-candles)
Cabinet Construction		Electrogalvanized steel with Isocide oven-baked epoxy-polyester powder coating, and Stainless Steel 304 (316 is optional)				
		1.5 mm (0.06") / 16 gauge thick				
Electrical	Full Load Amps 230 V	4.5 A	5.5 A	5.7 A	6 A	6.5 A
	Full Load Amps 115 V	9 A	11 A	11.5 A	12 A	13 A
	Heat Load	853 BTU / Hr	972 BTU / Hr	1177 BTU / Hr	1297 BTU / Hr	1774 BTU / Hr
Nominal Power Consumption		250W	285W	345W	380W	520W
Net Weight ***		243 kg / 536 lbs	283 kg / 624 lbs	350 kg / 772 lbs	426 kg / 939 lbs	580 kg / 1279 lbs
Shipping Weight ***		292 kg / 644 lbs	345 kg / 761 lbs	410 kg / 904 lbs	486 kg / 1072 lbs	640 kg / 1411 lbs
Shipping Dimensions, Maximum (W x D x H) ***		1200 x 950 x 1900 mm 47.2" x 37.4" x 74.8"	1550 x 950 x 1900 mm 61.0" x 37.4" x 74.8"	1950 x 950 x 1900 mm 76.8" x 37.4" x 74.8"	2150 x 950 x 1900 mm 84.6" x 37.4" x 74.8"	2720 x 950 x 1900mm 106.9" x 37.4" x 74.8"
Shipping Volume, Maximum ***		2.17 m <sup>3</sup> (77 cu.ft.)	2.80 m <sup>3</sup> (99 cu.ft.)	3.52 m <sup>3</sup> (124 cu.ft.)	3.88 m <sup>3</sup> (137 cu.ft.)	4.91 m <sup>3</sup> (173 cu.ft.)

\* Depth includes the remove-able arm rest and front cover.

When they are removed, depth is 790 mm (31.1").

\*\* Noise reading in open field condition / anechoic chamber. Noise reading in normal room varies by room size, layout, and background noise, but may reach roughly 3-4 dBA above these values

\*\*\* Cabinet only, excludes optional stand.

Class II Type A2 can be used to handle minute quantities of volatile toxic chemicals and trace amounts of radionuclides when thimble ducted. Use this option if chemical vapor re-circulation into the work zone is permitted.

Power Rating	Voltage (VAC)	Frequency (Hz)	Example
1	230	50	LA2-4A1
2	115	60	LA2-4A2
3	230	60	LA2-4A3

## Class II Type B2 Biological Safety Cabinets

TECHNICAL SPECIFICATIONS						
Labculture® Class II B2		LB2-3B _E	LB2-4B _E	LB2-5B _E	LB2-6B _E	LB2-8B _E
External Dimension* (W x D x H)	Without Base Stand	1115 x 852 x 1610 mm 44.0" x 33.5" x 63.3"	1420 x 852 x 1610 mm 56.0" x 33.5" x 63.3"	1725 x 852 x 1610 mm 68.0" x 33.5" x 63.3"	2030 x 852 x 1610 mm 80.0" x 33.5" x 63.3"	2600 x 852 x 1610 mm 102.4" x 33.5" x 63.3"
	With Optional Base Stand, 711mm (28") type	1115 x 852 x 2321 mm 44.0" x 33.5" x 91.4"	1420 x 852 x 2321 mm 56.0" x 33.5" x 91.4"	1725 x 852 x 2321 mm 68.0" x 33.5" x 91.4"	2030 x 852 x 2321 mm 80.0" x 33.5" x 91.4"	2600 x 852 x 2321 mm 102.4" x 33.5" x 91.4"
Internal Dimensions (W x D x H)		970 x 623 x 715 mm 38.2" x 24.5" x 28.1"	1270 x 623 x 715 mm 50.0" x 24.5" x 28.1"	1570 x 623 x 715 mm 61.8" x 24.5" x 28.1"	1870 x 623 x 715 mm 73.6" x 24.5" x 28.1"	2440 x 623 x 715 mm 96.0" x 24.5" x 28.1"
Usable Work Area		0.45 m <sup>2</sup> (4.8 sq.ft.)	0.6 m <sup>2</sup> (6.5 sq.ft.)	0.75 m <sup>2</sup> (8.1 sq.ft.)	0.9 m <sup>2</sup> (9.7 sq.ft.)	1.2 m <sup>2</sup> (13 sq.ft.)
Tested Opening		203 mm (8.0")	203 mm (8.0")	203 mm (8.0")	203 mm (8.0")	203 mm (8.0")
Average Airflow Velocity	Inflow	0.53 m/s (105 fpm)				
	Downflow	0.31 m/s (60 fpm)				
Airflow Volume	Inflow	376 m <sup>3</sup> /h (223 cfm)	492 m <sup>3</sup> /h (292 cfm)	608 m <sup>3</sup> /h (361 cfm)	724 m <sup>3</sup> /h (429 cfm)	945 m <sup>3</sup> /h (560 cfm)
	Downflow	628 m <sup>3</sup> /h (363 cfm)	822 m <sup>3</sup> /h (476 cfm)	1016 m <sup>3</sup> /h (588 cfm)	1210 m <sup>3</sup> /h (700 cfm)	1580 m <sup>3</sup> /h (914 cfm)
	CBV Exhaust Air Volume**	1127 m <sup>3</sup> /h (658 cfm)	1476 m <sup>3</sup> /h (862 cfm)	1824 m <sup>3</sup> /h (1065 cfm)	2173 m <sup>3</sup> /h (1269 cfm)	2835 m <sup>3</sup> /h (1656 cfm)
	Min Exhaust Static Pressure	400 Pa / 1.6 in H <sub>2</sub> O	375 Pa / 1.5 in H <sub>2</sub> O	375 Pa / 1.5 in H <sub>2</sub> O	400 Pa / 1.6 in H <sub>2</sub> O	475 Pa / 1.9 in H <sub>2</sub> O
	CBV Exhaust Static Pressure**	575 Pa / 2.3 in H <sub>2</sub> O	550 Pa / 2.2 in H <sub>2</sub> O	550 Pa / 2.2 in H <sub>2</sub> O	575 Pa / 2.3 in H <sub>2</sub> O	650 Pa / 2.6 in H <sub>2</sub> O
Supply ULPA Filter Typical Efficiency		≥99.999% for particle size between 0.1 to 0.3 microns				
Exhaust HEPA Filter Typical Efficiency		≥99.99% at 0.3 microns				
Maximum Sash Opening		508 mm (20")				
Sound Emission***	NSF / ANSI 49	57	58	59	60	61
	EN 12469	54	55	56	57	58
Fluorescent Lamp Intensity At Zero Ambient		> 1250 Lux (> 116 foot-candles)	> 1400 Lux (> 130 foot-candles)	> 1200 Lux (> 111 foot-candles)	> 1200 Lux (> 111 foot-candles)	> 1200 Lux (> 111 foot-candles)
Cabinet Construction	Main Body	Electro-galvanized steel with white oven-baked epoxy-polyester Isocide™ antimicrobial powder-coated finish				
	Work Zone	Stainless steel Type 304 with No.4 finish				
Electrical	Full Load Amps 230 V	4.5 A	5.5 A	5.7 A	6 A	6.5 A
	Full Load Amps 115 V	9 A	11 A	11.5 A	12 A	13 A
	Heat Load	566 BTU / Hr	645 BTU / Hr	781 BTU / Hr	860 BTU / Hr	1177 BTU / Hr
Nominal Power Consumption		166 W	189 W	229 W	252 W	345 W
Net Weight ****		279 kg / 615 lbs	317 kg / 699 lbs	359 kg / 791 lbs	438 kg / 966 lbs	591 kg / 1304 lbs
Shipping Weight ****		318 kg / 703 lbs	370 kg / 814 lbs	402 kg / 886 lbs	491 kg / 1083 lbs	651 kg / 1435 lbs
Shipping Dimensions, Maximum (W x D x H) ****		1210 x 950 x 1950 mm 47.6" x 37.4" x 76.8"	1520 x 950 x 1950 mm 59.8" x 37.4" x 76.8"	1900 x 950 x 1950 mm 74.8" x 37.4" x 76.8"	2150 x 950 x 1950 mm 84.7" x 37.4" x 76.8"	2720 x 950 x 1950 mm 107.0" x 37.4" x 76.8"
Shipping Volume, Maximum ****		2.24 m <sup>3</sup> (79.1 cu.ft.)	2.82 m <sup>3</sup> (99.6 cu.ft.)	3.52 m <sup>3</sup> (124.3 cu.ft.)	3.98 m <sup>3</sup> (140.6 cu.ft.)	5.04 m <sup>3</sup> (178.0 cu.ft.)

\*Height includes exhaust collar, and depth includes the remove-able arm rest and front cover. When they are removed, depth is 790 mm (31.1").

\*\*This Concurrent Balance Value (CBV) Exhaust Volume (per Pitot Duct Traverse) and Static Pressure at cabinet exhaust connection should be used when sizing the HVAC exhaust and supply.

\*\*\*Noise reading in open field condition / anechoic chamber. Noise reading in normal room varies by room size, layout, and background noise, but may reach roughly 3-4 dBA above these values

\*\*\*\*Cabinet only, excludes optional stand.

Class II Type B2 can be used to handle volatile toxic chemicals and radionucleotides because by default it's hard ducted. Use this option if chemical vapor re-circulation into the work zone is not permitted.

Power Rating	Voltage (VAC)	Frequency (Hz)	Example
1	230	50	LB2-4B1
2	115	60	LB2-4B2
3	230	60	LB2-4B3

# Purchase Specifications LA2 Class II A2, LR2 Class II A2, LB2 Class II B2 Biological Safety Cabinets

## A. General Performance and Certifications

1. The biological safety cabinet shall comply with the following international standards, and the manufacturer shall provide a certified copy of containment and performance tests equivalent to or greater than specified in the following independent international standards for Class II per NSF / ANSI 49 (USA), JIS K3800 (Japan), SFDA YY-0569 (China), and EN 12469 (Europe).
2. The cabinet shall protect (a) the operator and laboratory environment from particulates generated within the work zone; (b) the product and process within the work zone from airborne contamination from ambient air; (c) and the product and process within the work zone from cross contamination.
3. The cabinet shall be tested by KI-Discus test (European Standard EN12469:2000) on statistical sampling basis to validate operator/personnel protection. The retention efficiency for the front aperture shall be not less than 99.999%. Microbiological testing for cabinet performance shall also be performed on a statistical sampling basis.
4. Each cabinet shall be listed by Underwriters' Laboratories (UL, CUL) or CE for electrical safety.
5. Original documentation specific to each cabinet serial number shall be provided with the cabinet and maintained in the manufacturers' records. Test data verifying all performance criteria shall be available upon request to include: (a) inflow velocity through direct inflow measurement method; (b) downflow velocity and uniformity; (c) filter leak scan with aerosol challenge for both filters; (d) electrical safety.

## B. Filtration System

6. The cabinet shall have one supply downflow filter and one exhaust filter. For Class II A2: Both filters shall be ULPA per IEST-RP-CC001.3 and H14 per EN1822. For Class II B2: The downflow filter shall be ULPA type per IEST-RP-CC001.3 and H14 per EN1822 H14, and the exhaust filter shall be HEPA per IEST-RP-CC001.3 and H13 per EN1822.
7. The filters shall be constructed with aluminum frame with mini-pleat media design without aluminum separators; no wood or fiberboard shall be used in the filter assembly.
8. An integral filter guard shall be affixed to prevent damage to the filter media. On Class II A2, the exhaust filter shall further be protected by staggered exhaust damper.
9. The filters shall be (a) individually scan tested by the manufacturer, (b) individually scan tested after assembly, and (c) easily accessible for scan testing on site, by means of a dedicated upstream sampling port accessible from within the cabinet.
10. The supply filter shall be angled and oriented to the 10° cabinet front angle to optimize downflow uniformity over the work surface and improve the front aperture containment.
11. A removable, perforated metal diffuser shall be installed below the supply filter to optimize airflow uniformity and to protect the downflow filter from damage.

## C. Blower System

12. The cabinet shall have an energy efficient DC ECM motor that saves 70% energy compared to conventional AC motor.
13. The blower/motor system shall automatically maintain stable airflow, despite building supply voltage fluctuation and increased filter loading.
14. (Apply only to LA2 and LR2) The cabinet shall incorporate Night Setback / Standby Mode, to reduce the blower speed when the cabinet is not being used by the operator, while maintaining containment at static condition, as verified by KI-Discus.
15. The blower/motor system shall be enclosed within a dynamic chamber shaped steel plenum that is integrated with the removable ULPA / HEPA filters to simplify filter changing. Fabric plenum is not allowed.
16. The integral damper shall be externally adjustable, without the need to decontaminate the cabinet.

## D. Cabinet Design, Construction, Cleaning

17. The cabinet shall be of triple wall design whereby all positive pressure plenums handling contaminated air shall be surrounded by negative pressure. No positive pressure areas shall be accessible external to the cabinet. The third wall shall conceal utilities.
18. The cabinet shall have a one piece stainless steel 304 side and back wall with  $\geq \frac{1}{4}$ " radius back corners to allow easy surface decontamination. Siliconed joints and 90° bends on the back corners are not allowed, because they are hard to clean and can harbor contaminants.
19. The work tray shall be one-piece, integrated with the front grille, removable, stainless steel grade 304 with 45° angle on all sides, without crevices or joints.
20. The cabinet shall have a stainless steel grade 304, one piece drain trough with 45° angle on all sides, with smooth polished corners, to enable easier surface decontamination. No 90° angle is allowed on any side of the drain trough.
21. The closed side wall below the normal sash operating height shall be sealed without perforations, return air slots or concealed areas which can harbor contaminants.
22. The cabinet shall be free of sharp edges, nonfunctional protrusions, bolts, screws or hardware, and all metal edges shall be deburred.
23. The cabinet exterior top shall be slanted to discourage placement of foreign objects and to maintain proper exhaust airflow.

## E. Ergonomics and Convenience

24. The front sash shall be frameless to maximize visibility. Sash glass shall be safety glass.
25. The sash counterbalance shall be suspended on two high-strength cables, and for safety, the sash shall lock into position in the event one cable becomes detached.
26. Magnetic, not mechanical, proximity sensors shall work in conjunction with the control system to indicate proper sash position for containment.
27. Fluorescent lamps shall be mounted behind the control panel module out of the work zone. Electronic ballasts shall be used to eliminate flicker, extend lamp life and reduce heat output.
28. The UV lamp shall operate via an automatic timer with automatic shut-off to extend the UV lamp life, and shall be interlocked with the blower/motor and fluorescent lights for safety.
29. The cabinet shall be designed with a 10° angled front to optimize user comfort, reduce glare and maximize reach into the work area.
30. The front grille shall be angled to prevent airflow blockage by accidental placement of objects.
31. Penetrations for petcocks and service fittings shall be provided; penetrations shall be offset to improve user access.
32. The cabinet shall accommodate an optional mounting stand for fixed-height or adjustable height configurations.
33. The cabinet shall be equipped with arm rest that is raised above the inflow grille to improve comfort and prevent the operator's arms from blocking the inflow grille. The arm rest shall be made from one-piece stainless steel 304 that can withstand decontaminant agents and UV lamp.

## F. Certification, Service and Decontamination

34. The cabinet shall be approved for both hydrogen peroxide vapor (HPV) and formaldehyde decontamination protocol.
35. All panels leading to potentially contaminated and / or hazardous areas shall be color coded red.
36. All components with the exception of blower / motor and ULPA filters shall be located outside of contaminated air spaces to facilitate servicing without the need to decontaminate the cabinet.
37. All exterior surfaces shall be painted with a permanent antimicrobial inhibitor coating to minimize contamination.

## G. For Cabinets with Microprocessor Control System: LA2 and LB2 (Not applicable for LR2)

38. All cabinet functions shall be managed by a programmable microprocessor control system capable of software updates via Internet / email downloads.
39. The microprocessor controller shall be centrally mounted on the main control panel, angled down toward the user, for easy access and ADA-compliant.
40. The controller shall include soft-touch keypad controls and backlit LCD display to control the blower/motor, light, UV lamp, electrical outlet(s) and menu.
41. The LCD shall be large enough to simultaneously display cabinet model, clock, inflow, downflow, sash status, airflow status, and cautionary message should a deviation from normal operating parameters occur.
42. The controller shall be user programmable on site, to enable or disable functions such as PIN (personal identification number) access restriction, cabinet start-up protocol, airflow alarm and other microprocessor controlled operations as outlined in the user manual.
43. When programmed ON, the start-up protocol shall perform an automatic pre-purge and post-purge cycle to ensure proper cabinet operation.
44. The controller shall include a blower / motor hours meter to display aggregate motor running time to assist in predictive maintenance.
45. Audible and visual alarms shall be provided for unsafe conditions such as improper airflow or sash opening.
46. The audio alarm shall be able to be muted by the user at adjustable duration, and after that, the audio alarm is automatically resumed.
47. Airflow shall be monitored by a temperature compensating, thermistor-based, true air velocity sensor mounted in the cabinet.
48. The airflow display and alarm system shall be individually calibrated before shipment.
49. Diagnostics button should be available on the control panel, to easily check the cabinet operating parameters and sensor calibration to assist servicing.
50. The cabinet shall have field calibration mode that simplifies on-site calibration.
51. A selectable Quickstart mode should be available to automatically turn the blower and lights on/off by moving the sash window to the correct position.
52. The BSC shall have RS 232 data output port for remote monitoring of cabinet operating parameters.
53. TCP / IP converter shall be available as an option, to connect RS 232 to network for remote monitoring.
54. Built-in zero volt relay contact to signal the exhaust blower or exhaust damper to turn ON / OFF when the cabinet internal blower is turned ON / OFF.
55. Built-in zero volt relay contact to send signal to building remote alarm when the cabinet internal alarm is activated.

## G. For Cabinets with Manual Control System: LR2 (Not Applicable for LA2 and LB2)

38. The cabinet shall be controlled by simple rocker switches. The switch shall prevent the fluorescent lamp and UV lamp from being turned on at the same time
39. Filter pressure gauge shall be used to continuously monitor the filter plenum pressure
40. Manually adjustable mechanical UV timer shall be used to control the duration of UV lamp activation to prolong the UV lamp.

# ESCO GLOBAL NETWORK

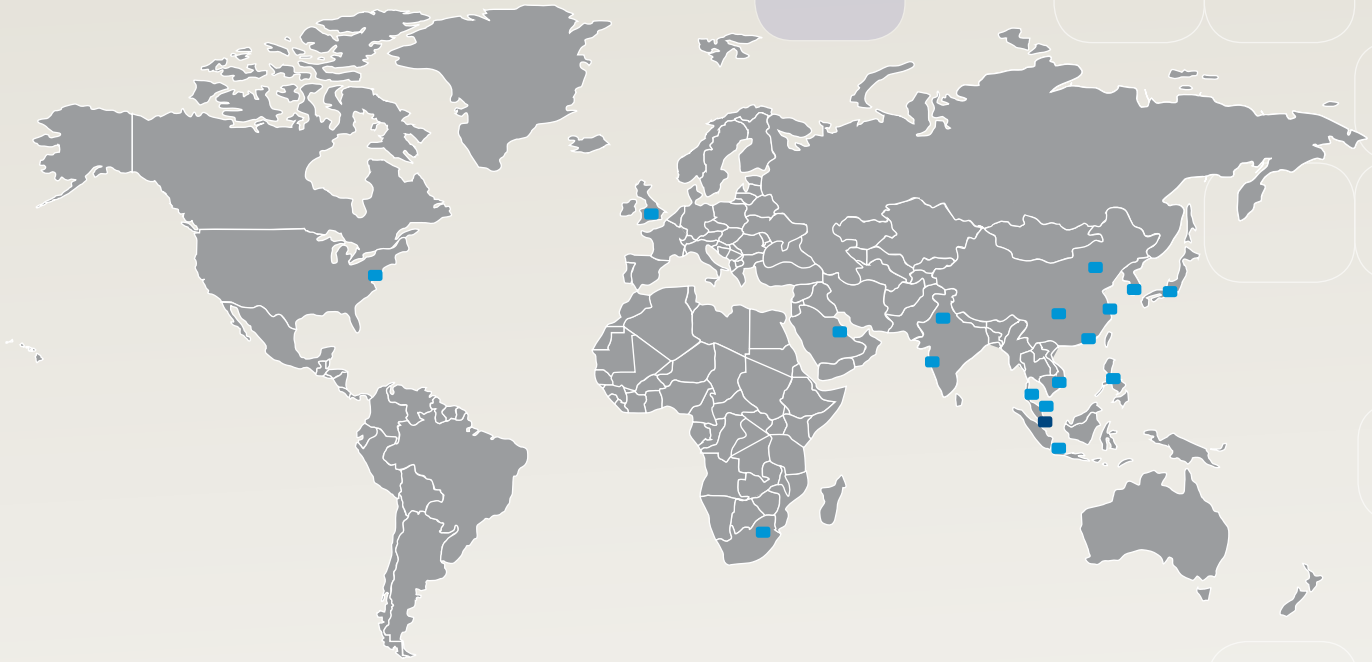

- ART Equipment
- Biological Safety Cabinets
- CO<sub>2</sub> Incubators
- Compounding Pharmacy Equipment
- Containment / Pharma Products
- Ductless Fume Hoods
- Freeze Dryer
- Lab Animal Research Products
- Laboratory Fume Hoods
- Laboratory Ovens and Incubators
- Laminar Flow Clean Benches
- PCR Cabinets
- PCR Thermal Cyclers
- Powder Weighing Balance Enclosures
- Ultra-low Freezers

*The Esco Group of Companies is a global life sciences tools provider with sales in over 100 countries. The group is active in lab equipment, pharma equipment and medical devices. Manufacturing facilities are located in Asia and Europe. R&D is conducted worldwide spanning the US, Europe and Asia. Sales, service and marketing subsidiaries are located in 12 major markets including the US, UK, Singapore, Japan, China and India. Regional distribution centers are located in the US, UK, and Singapore.*

Life Science • Chemical Research • Assisted Reproductive Technology (ART) • Pharmaceutical Equipment • General Equipment

# ESCO

WORLD CLASS. WORLDWIDE.

Esco Technologies, Inc. • 2940 Turnpike Drive, Units 15-16 • Hatboro, PA 19040, USA  
 Toll-Free USA and Canada 877-479-3726 • Tel 215-441-9661 • Fax 215-441-9660  
 us.escoglobal.com • usa@escoglobal.com

Esco Micro Pte. Ltd. • 21 Changi South Street 1 • Singapore 486 777  
 Tel +65 6542 0833 • Fax +65 6542 6920 • mail@escoglobal.com  
 www.escoglobal.com

**Esco Global Offices** | Manama, Bahrain | Beijing, China | Chengdu, China | Guangzhou, China | Shanghai, China | Bangalore, India  
 Delhi, India | Mumbai, India | Jakarta, Indonesia | Osaka, Japan | Kuala Lumpur, Malaysia | Melaka, Malaysia | Manila, Philippines  
 Singapore | Seoul, South Korea | Salisbury, UK | Philadelphia, PA, USA | Hanoi, Vietnam